



Packaging
Box
Package
Print



baris.ambalaj



baris_ambalaj



baris.ambalaj

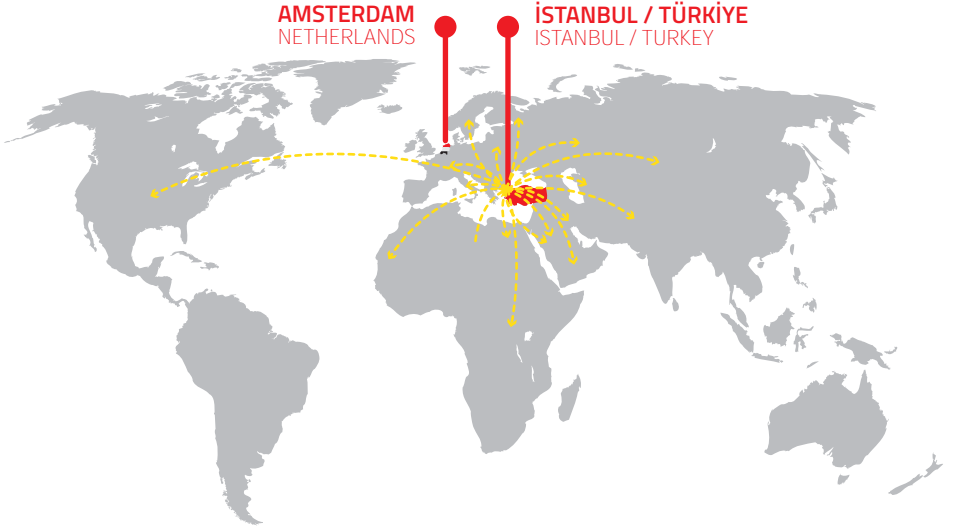

Dünyaya üretiyoruz!

Ürünlerimizi dünyanın 50'den fazla ülkesine ihraç ediyoruz!



We are producing to the world!

We export our product to 50 countries of the world!

B BARIS
Ambalaj / Kutu / Koli / Matbaa

Barış Ambalaj

1991 yılında İstanbul'da kurulan **Barış Ambalaj**, başta otomotiv yedek parça ambalajı sektöründe çalışmalarına kesintisiz ve profesyonel bir şekilde gelişerek devam etmektedir. 7/24 sizlere kesintisiz olarak hizmet veren, zengin üretim çeşidi, gelişmiş teknolojik imkanlarla donatılmış modern ve yüksek kapasiteli üretim tesisi, sürekli kendini geliştirmeyi hedefleyen ve yeni projeler üzerinde çalışan AR-GE departmanı ile iç pazarın tamamında ve dünyanın her yerine gerçekleştirdiğimiz ihracatlarla sektörün önde gelen markaları arasında yer almaktayız.

Tecrübemizle Fark Yaratıyoruz!..

Hizmet sektörümüz olan otomotiv yedek parça ambalajında müşterilerimizin A'dan Z'ye tüm ihtiyaçlarını tek bir yerden elde edebileceği entegre bir tesis olmasının avantajıyla **Barış Ambalaj**, büyümeye ve gelişmeye devam etmektedir. **Barış Ambalaj** önce sizleri dinliyor, istekleriniz doğrultusunda ihtiyacınız olanı en iyi kalitede ve en uygun fiyatla sizlere sunuyor. Kurulduğu günden bu yana kaliteye verdiği önem ve zoru başarma azmiyle sektörde kendine önemli bir yer edinmiş ve bu ilkelerinden asla vazgeçmemiştir.

Vizyonumuz

Türkiye'nin ve dünyanın her yerine, güvenilir ve aynı kalitede hizmet sunan, müşteri ve insan kaynağını en önemli değer olarak kabul eden, geçmişine yakışır şekilde sürekli fark ve değer yaratan, rakiplerine örnek olmayı başarabilen, sektöründe lider bir firma olmaktır.

Misyonumuz

Müşterilerimizin ihtiyaç ve beklentilerini en iyi şekilde anlayarak, onlara en uygun çözüm önerilerini sunan, geniş ürün ve hizmet yelpazesıyla etkin ve hızlı şekilde ulaştıran, etik değerlerinin ve sosyal sorumluluğunun bilincinde olarak dünya standartlarında faaliyet gösteren, müşteri memnuniyetini her şeyden üstün tutan bir işletme olmaktır.

Europe Packaging

We are a global packaging company with the key business focus on manufacturing and supplying of diverse packaging solutions to our clients. Europe Packaging operates since 1991, serves hundreds of customers with production facilities domestic and abroad and comprises of best people to accomplish its vision in the light of the current size and scope.

Europe Packaging maintains a strong presence in the Turkish market under Baris Ambalaj name. All products manufactured and introduced to its target audience are recognized for their superior quality. As a result of the rising market and rapid sales growth, Europe Packaging moved to its new and modern manufacturing 7000 square meter facility in Avcilar district of Istanbul in 2016.

Our customer base varies from automotive spare parts industry to other metal industries and also clothing, cosmetics etc. Our product range consists of Corrugated boxes, Shipping Containers, Labels, VCI Papers and Duct tapes. Being highly specialized in corrugated box business, Europe Packaging keeps 5000 types of different tools to supply in short order customers with.

The major fundamental principle at Europe Packaging is to attain a top level of customer satisfaction. We strive to ensure market demands are met and we are committed to offering the ultimate quality products and services to all customers.

Values

• Customer Commitment

We target absolute customer satisfaction by adding value to the product and reflecting the customer's ID in the best possible way;

• Quality

We maintain brand strength and material quality by careful testing, screening and designing each package;

• Environmental Ethics

We think about environment by using raw materials in an efficient and recyclable manner at every stage of the production;

• Innovation

We keep innovative approach by improving current packaging and printing technologies in response to the expectations of our customers.

Üretim Aşaması

Production Process

Çözüm İçin...! *For Solution...!*

Sivama - *Plastering*

Kesim - *Cutting*

Ofset Baskı - *Offset Printing*



Packaging - Box - Package - Print

Fikir

Her ürünün kendine has özellikleri bulunmaktadır. Bu özellikler de bizlere tasarımla ilgili ana fikri vermektedir.

İdea

Each product has its own characteristics. These features give us the main idea of design.

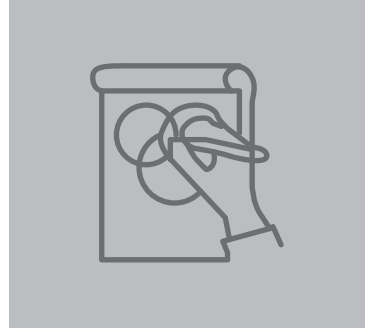

Kutu Modeli

Bize aktarmış olduğunuz bilgi ve düşüncelere istinaden ürünlerinize uygun en kullanışlı kutu modeli tarafımızca oluşturulmaktadır.

Box Model

Transfer to us that you have your product information and ideas with reference to the most appropriate model is handy box created by us.

Tasarım

Bariş Ambalaj olarak, grafik ve tasarım bölümünde ürünlerinizin rafta dikkat çekici ve seçilebilir olması için hayal edemeyeceğiniz tasarımları gerçekleştiriyoruz.

Design

As Bariş Ambalaj, we design and graphic that you cannot imagine for your products to be remarkable and selectable on the shelf in the graphics and design department.



Renk Seçimi

Tasarımın en önemli safhalarından biri olan renk seçiminde, Pantone kataloğundaki geniş renk seçeneklerinden yararlanabilir ya da firmanızın "Kurumsal Kimliğine" uygun renkleri oluşturabiliriz

Colour Selection

One of the most important choice of colors in the design stage, can benefit from the wide range of colors in the Pantone catalog or your company's "Corporate Identity" can create the appropriate colors.



Prova Baskı

Bu bölüm seri üretimden önceki son adım olup, dijital ortamda hazırlanan ürünün onaylanması ve son kontrollerinin yapılması amacıyla örnek kutu üretimi yapılır.

Rehearsal Print

This section is the final step prior to series production, approval of the product of the digitized samples can manufacturing is done in order to make the final control.

Baskı

Baskı, üretimin en önemli aşamalarından biridir. Önceden yapılan tüm işlemlerin onaylanması ile birlikte seri üretime geçilir. Seri üretim sürecinde firmamızın sahip olduğu en üst düzey teknolojiler kullanılarak müşterilerimize en iyi baskı kalitesini sunuyoruz.

Printing

Printing is one of the most important stages of production. Serial production started with the approval of all the transactions made in advance. In the serial production process, we offer the best printing quality to our customers by using the highest level technologies that our company has.

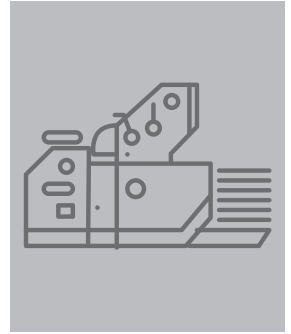

Laminasyon

Yapılan baskıyı dış etkenlerden korumak ve uzun ömürlülüğü sağlamak için dış yüzeyin sefeon, lak veya vernik ile kaplanmasıdır.

Lamination

To protect the pressure from external factors and to provide longevity, the outer surface is covered with cellophane, lacquer or varnish.

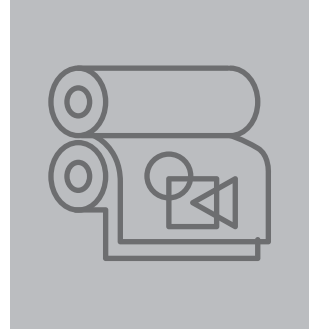

Kesim Bıçakları

Ürün, tasarım ve müşteri talebine göre kutu modeli FEFCO standartları çerçevesinde belirlenir ve buna uygun olarak bıçak kesim kalıpları hazırlanır.

Cutting Blades

The product design and is determined in accordance with standard FEFCO box model according to customer demand and it was prepared according to the blade cutting dies.

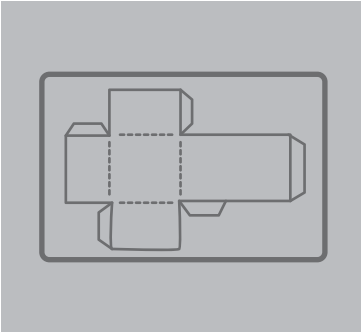
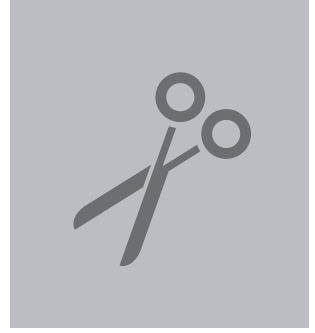

Kesim

Baskı ve laminasyonu yapılan ürünlerin, belirlenen ölçülere göre hazırlanmış bıçaklar ile kesim işlemi tamamlanır. Bu sayede ürünün son şekli oluşur.

Cutting

Printing and laminating made products, with the cutting blades prepared according to the specified measurement is completed. In this way, the final shape of the product occurs.

Hazır Ürün

Üretim sürecindeki aşamaların tamamı gerçekleştikten sonra ürün, kutu haline getirilip son kez kontrol edilir. Son kontrolde bir sorun bulunmaması durumunda müşteriye sevk edilir.

Ready-Made Products

After all the stages of the production process are realized, the product is checked into the box and checked for the last time. If there is no problem in the last check, it is shipped to the customer.



Kalite

Ön kalite kontrol, üretim kalite kontrol ve ürün hazır olduktan sonra yapılan Son **Kalite Kontrol birimleri** sayesinde her birim birbirinin müşterisi olarak üretimi yapmaktayız.

Quality

Preliminary quality control, quality control and production thanks to ready-made products after the last quality control units have been producing each unit as customers of each other.



Ambalajınızı
adım adım
oluşturalım.

*Step by step
we create your
Packaging.*

Oluklu Çeşitleri - Corrugated Types

ONDULE

F DALGA - F WAVE 0.9 ile 1.2 mm

E DALGA - E WAVE 1.2 ile 2 mm

B DALGA - B WAVE 2.4 ile 3 mm

C DALGA - C WAVE 3.5 ile 4 mm

TRIPLEX

B+C+A DALGA - B+C+A WAVE 7 ile 10 mm

SAFİA

F DALGA - F WAVE 0.9 ile 1.2 mm

E DALGA - E WAVE 1.2 ile 2 mm

B DALGA - B WAVE 2.4 ile 3 mm

C DALGA - C WAVE 3.5 ile 4.2 mm

E+E DALGA - E+E WAVE 2.6 ile 2.9 mm

E+B DALGA - E+B WAVE 3.6 ile 4.1 mm

E+C DALGA - E+C WAVE 5 ile 6.5 mm

B+C DALGA - B+C WAVE 6 ile 7.6 mm

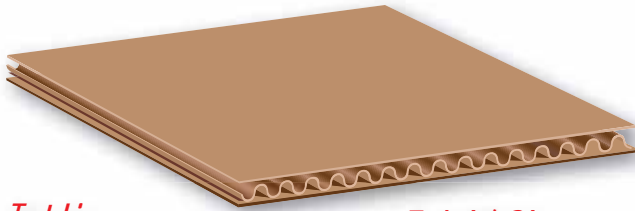

Test Liner — *Tutkal / Glue*

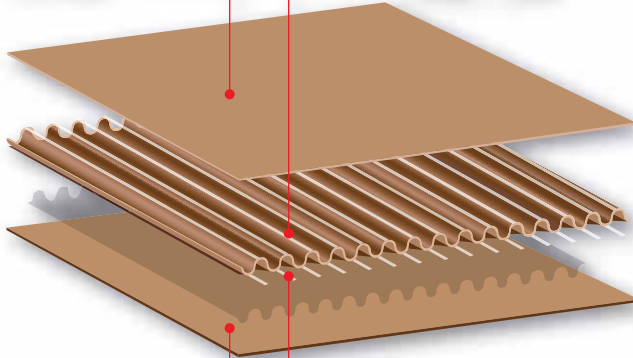

Test Liner — *Tutkal / Glue*

Receiver Model Kutu

*Receiver
Model Box
Fefco Code: 0471*

Receiver Model Kutu - Receiver Model Box

Fefco Code: 0471

Receiver kutu ürününüzün kalitesi ve marka değeriniz açısından en iyi kutu tipi'dir. Kutunun kapanma şeklinden dolayı diğer kutu tiplerinden daha güvenli ve daha dirençlidir. İçerisine konulacak ürünü dış etkenlerden daha etkili şekilde korur.

Receiver box is the best box type for your product quality and brand value. Closing the box It is safer and more resistant than 'American' and other box types. Product to be placed inside protect against damage. The product is aesthetically pleasing.



Fefco Code: 0471



Güneş Işığına
Karşı Koruma
Protection Against
Sunlight



Nem'e Karşı
Dirençli
Resistant to
Moisture



Darbelere Karşı
Dirençli
Resistant to Shock



Ekonomik
Ürün
Economic Product



Kağıt Oluklu
Mukavva
Paper Corrugated
Cardboard



Çevreci Ürün
Geri Dönüşüm
Environmental
Product Recycling

- Ezilme, bükülme, kırılmalara karşı dirençlidir.
- Ekonomiktir. Bütçenize ek yük getirmez.
- Firmanızın uluslararası alanda değerini artırır.
- Raf ömrü uzundur daha az deforme olur.
- Kutuları üst üste dizmek kolay ve güvenlidir.
- Ürünüze estetik bir görünüm kazandırır.



- Resistant to crushing, twisting, breakage.
- It's economical. No additional burden on your budget.
- Increase the value of your company's international field.
- Shelf life is longer, less deformed.
- Putting the boxes on top is easy and safe.
- This type gives an aesthetic appearance to your product.



Fefco Code: 0471

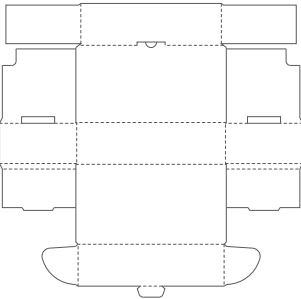

Fefco Code: 0471

- Nakliyede yer tasarrufu sağlar.
- Ürünüzü rahatlıkla kargoya verebilirsiniz.
- Rafta ürünüzd dikkat çekici durmasını sağlar.
- En önemli özelliği kapanma şeklidir.
- Save space on the shipping.
- Your product can easily carry cargo.
- It makes your shelf product stand out.
- The most important feature is the closure of the box.



Packaging - Box - Package - Print

LEADER IN THE PACKAGING SECTOR IN TURKEY...

"From Good To The Best..."

32 Years of
Experience

Supplier for
OEM, OES and IAM

Specialised in Automotive
Spare Parts Business

444 8 940 | kutucum.com

Amerikan Model Kutu

*American
Model Box*

Fefco Code: 0215

Amerikan Model Kutu - American Model Box

Fefco Code: 0215

Amerikan kutu tipi alttan kilitlemeli olarak üretilir. Ürünü kutuya koymadan önce kurma işlemi yapılmaktadır. Yandan yapıştırırmalı veya Tel Dikişli olarak üretilir.

The American box type is manufactured with a lock. Installation is done before putting the product in the box. It is produced as Side Seamed or Wire Seamed.



Fefco Code: 0215

1



2



3



Güneş Işığına
Karşı Koruma
Protection Against
Sunlight



Yandan
Yapıştırırmalı
Wire Stitch



Tel Dikişli
Wire Stitch



Ekonomik
Ürün
Economic Product



Kağıt Oluklu
Mukavva
Paper Corrugated
Cardboard



Çevreci Ürün
Geri Dönüşüm
Environmental
Product Recycling



Fefco Code: 0215

- Raf ömrü uzundur daha az deforme olur.
- Kutuları üst üste dizmek kolay ve güvenlidir.
- En önemli özelliği alttan kilitleme özelliği.
- Kurulumu kolay ve pratiktir.
- Firmanızın uluslararası alanda değerini artırır.
- En çok kullanılan kutu modelidir.
- Kutuları üst üste dizmek kolay ve güvenlidir.

- Shelf life is longer this model quicker deformed than Receiver model.
- Putting the boxes on top is less secure than the Receiver.
- The most important feature is locked from the bottom.
- Installation is easy and practical.
- Increase the value of your company's international field
- The most commonly used box model.
- Putting the boxes on top is easy and safe.

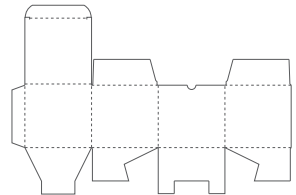

Fefco Code: 0215

B BARIS[®]
Ambalaj / Kutu / Koli / Matbaa
Packaging - Box - Package - Print



**AMBALAJDA
BENZERSİZ AYRICALIK
UNIQUE PRIVILEGE IN PACKAGING**

Ambalaj - Kutu - Koli - Matbaa
Packaging - Box - Package - Print

Çift Kapak Model Kutu

*Double Cover
Model Box
Fefco Code: 0211*

Çift Kapak Model Kutu - Double Cover Model Box

Fefco Code: 0211

Genellikle küçük ve hafif ürünler için kullanılır.
2 farklı yönden açılma özelliğine sahiptir.
Çift taraflı açılabilmesi en büyük avantajdır.
Ekonomik ve pratik kullanımı vardır.

*It is usually used for small and light products.
It has the ability to open in 2 different directions.
Double-sided is the biggest advantage.
Economic and practical use.*



Fefco Code: 0211



Güneş Işığına
Karşı Koruma
Protection Against
Sunlight



2 Farklı
Yönden Açılma
2 Opening from
different directions



Hafif
Kilolar İçin
For Light Kilos



Ekonomik
Ürün
Economic Product



Kağıt Oluklu
Mukavva
Paper Corrugated
Cardboard



Çevreci Ürün
Geri Dönüşüm
Environmental
Product Recycling

- Çift taraflı açılabilme özelliği pratik kullanım sağlar.
- Ekonomiktir. Bütçenize ek yük getirmez.
- Raf dizilimlerinde kolaylık sağlar.
- Raf ömrü uzundur daha az deforme olur.
- Çift taraflı açılabilmesi raf diziliminde daha avantajlıdır.

- *The double sided opening feature provides practical use.*
- *It's economical. No additional burden on your budget.*
- *It provides convenience in rack layout.*
- *Shelf life is longer, less deformed.*
- *Double sided opening is more advantageous in rack layout.*



- Marka ve ambalaj tasarımını ön planda olmasını sağlar.
- Çift taraflı açılma özelliği markanızın ön planda olmasını sağlar.
- Ezilme, bükülme, kırılmalara karşı dirençlidir.
- Ekonomiktir. Bütçenize ek yük getirmez.
- Firmanızın uluslararası alanda değerini artırır.

- *Makes the brand and packaging design to be the front-line.*
- *The double-sided opening feature ensures that your mark is on the front panel.*
- *Resistant to crushing, twisting, breakage.*
- *It's economical. No additional burden on your budget.*
- *Increase the value of your company's international field.*

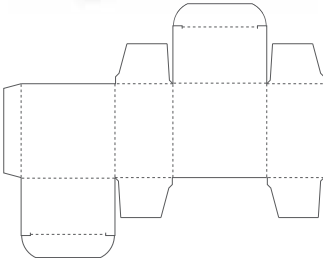

Fefco Code: 0211

YEDEK PARÇA AMBALAJINDA LİDER

since
1991

Ambalaj - Kutu - Koli - Matbaa
Packaging - Box - Package - Print

Çözüm için...!
For solution...!
شريك راه حل



B BARIS
Ambalaj / Kutu / Koli / Matbaa

www.kutucum.com

Koli Kapama

Box Cover

Fefco Code: 0201

Koli Kapama - Box Cover

Fefco Code: 0201

Büyük ve Ağır ürünler için kullanılır.
Maliyet, zaman ve yer avantajı sağlar.
Bant ve zımba ile kapatılıp ürün içine yerleştirilir
ve son kullanıcıya ulaştırılır.

*Used for large and heavy products. It provides cost,
time and space advantages.
With tape and stapler Closed and placed in the
product and delivered to the end user.*



Fefco Code: 0201

1



2



3



Güneş Işığına
Karşı Koruma
*Protection Against
Sunlight*



Büyük
Ürünler İçin
*For Large
Products*



Ağır
Kilolar İçin
For Heavy Kilos



Ekonomik
Ürün
Economic Product



Kağıt Oluklu
Mukavva
*Paper Corrugated
Cardboard*



Çevreci Ürün
Geri Dönüşüm
*Environmental
Product Recycling*

- Ezilme, bükülme, kırılmalara karşı dirençlidir.
- Büyük ürünlerinizde taşıma ve nakliye avantajı sağlar.
- Son dış koli olduğundan dolayı marka değerini artırır.

- *Resistant to crushing, twisting, breakage.*
- *It provides transportation and transport advantages for your large products.*
- *It increases brand value because it is the last outer box.*



- Uzun raf ömrü vardır. Daha az deforme olur.
- Kollileri üst üste dizmesi kolay ve güvenlidir.
- *Long shelf life. Less deformity.*
- *The stacking of the arms is easy and safe.*



Fefco Code: 0201

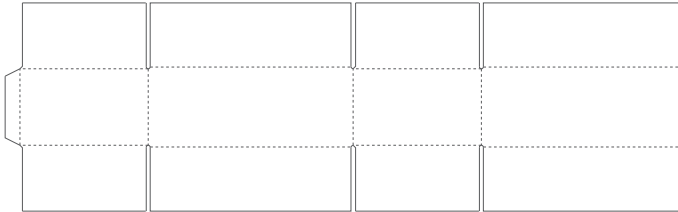

Fefco Code: 0201

ENDÜSTRİYEL AMBALAJDA ETKİN ÇÖZÜMLER

since
1991

Ambalaj - Kutu - Koli - Matbaa
Packaging - Box - Package - Print

Çözüm için...!
For solution...!
شريك راه حل



B BARIS
Ambalaj / Kutu / Koli / Matbaa

www.kutucum.com

EFFECTIVE SOLUTIONS IN
INDUSTRIAL PACKAGING

Dip Kilitli

Locked Bottom Side

Fefco Code: 0713

Dip Kilitli - Locked Bottom Side

Fefco Code: 0713

Dip kilitli kutuda kilit sistemi bulunduđu için kutu haline gelmesi kolaydır. Pratik ve hızlı kullanımı vardır. Seri üretimlerde en çok tercih edilen kutu modelidir.

It is easy to get into the box because there is a lock system in the locked bottom side box. It is practical and quick to use. It is the most preferred box model in mass production.



Fefco Code: 0713

1



2



3



Güneş Işıđına
Karşı Koruma
Protection Against
Sunlight



Kilit
Sistemi
Lock System



Hafif
Kilolar İçin
For Light Kilos



Ekonomik
Ürün
Economic Product



Kağıt Oluklu
Mukavva
Paper Corrugated
Cardboard



Çevreci Ürün
Gerİ Dönüşüm
Environmental
Product Recycling

- Özel kilit sistemi sayesinde hızlı ve pratik kullanım sağlar.
- Seri üretim yapan firmalarda zaman avantajı sağlar.

- *Special locking system, provides quick and practical use.*
- *It provides time advantage for mass production companies.*

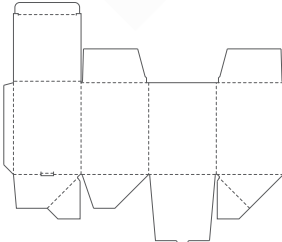

Fefco Code: 0713

- Kurulumu en kolay ve en hızlı kutu modelidir.
- Ezilme, bükülme, kırılmalara karşı dirençlidir.
- Firmanızın uluslararası alanda değerini artırır.
- *Installation is the easiest and fastest box model.*
- *Resistant to crushing, twisting, breakage.*
- *Increase the value of your company's international field.*



Diđer Ürün Gruplarımız

*Our Other Group
Of Products*

Sevk Kolisi

Shipped Boxes

Kurumsal Kimlik

Corporate Identity

Hologramlı ve Hologramsız Etiket

Label With Hologram and Non Hologram

Koli Bandı

Duct Tape

Taşıma Poşeti

Carry Bag

Rulo Poşet

Roll Bag

Sülfite Kağıt

Sulphite Paper

VCI Kağıt ve Poşet

VCI Paper and Bag

Sevk Kolisi - Shipped Boxes

Fefco Code: 0312

İhrac ettirdiğiniz ürünlerin güvenliği için kullanılır.
Sevkiyat esnasında ürününüzün zarar görmesini engeller.
Hızlı ve kolay yükleme imkanı sağlar.
Ezilme, bükülme, kırılmalara karşı dirençlidir.

*Used for the safety of the products you export.
Prevents damage to your product during shipment.
Provides quick and easy loading.
Resistant to crushing, twisting, breakage.*



Fefco Code: 0312



Güneş Işığına
Karşı Koruma
Protection Against
Sunlight



Büyük
Ürünler İçin
For Large
Products



Ağır
Kilolar İçin
For Heavy Kilos



Ekonomik
Ürün
Economic Product



Kağıt Oluklu
Mukavva
Paper Corrugated
Cardboard



Çevreci Ürün
Geri Dönüşüm
Environmental
Product Recycling

Baskılı ve Baskısız Kutu

Printed and Unprinted Box

Fefco Code: 0201

- Maliyet ofset kutularına göre daha azdır.
- Özel ürünler ve sade bir görünümü olduğunu için tercih edilebilir.
- Markanızın rafta rakip markalar arasından öne çıkmasını sağlar.

- *Cost is less than offset boxes.*
- *It can be preferred because it is a special product and a plain appearance.*
- *Allows your brand to stand out from the raft competitors.*



Fefco Code: 0471



Fefco Code: 0201



Güneş Işığına
Karşı Koruma
Protection Against
Sunlight



Büyük
Ürünler İçin
For Large
Products



Ağır
Kilolar İçin
For Heavy Kilos



Ekonomik
Ürün
Economic Product



Kağıt Oluklu
Mukavva
Paper Corrugated
Cardboard



Çevreci Ürün
Geri Dönüşüm
Environmental
Product Recycling

Kurumsal Kimlik - Corporate Identity

Sizin Kurumsal Kimliğiniz Var mı?

Firmanızın kurumsallaşması ve markalaşması için ilk önce creative bir kurumsal kimliğe ihtiyacınız var.

Do You Have Corporate Identity?

For the institutionalization and branding of the firm first You need a creative corporate identity.



Broşür / Brochure



Katalog / Catalog



Insert/Inserts



Blok Not / Block Note



Küp Not / Cube Note

Ön/Front Arka/Back



Çakmak / Lighter



Kalem / Pen

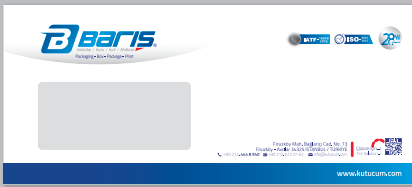

Pencereli Zarf / Window Envelope



Kartvizit / Business Card

Şerit hologramlı etiket (Label with ribbon hologram)

Sample 1

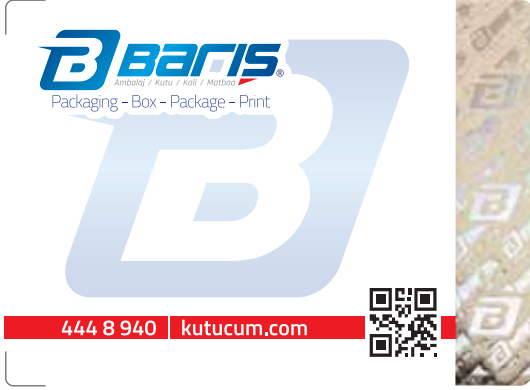

Hologram

Sample 3



Kare hologramlı etiket (Label with square hologram)

Sample 2



Güvenlikli Hologram
(Security Hologram)

Sample 4



Koli Bandı - Duct Tapes

Şeffaf, Kahverengi ve Özel Baskılı Polipropilen koli bantları sunuyoruz.

Ayrıca Polipropilen (PP) , olarak bilinen polipropilen paketleme bantlar dahil olmak üzere geniş bir uygulama yelpazesinde kullanılabilir bir termoplastik polimerdir. bu bantlar 3 farklı yapıştırıcı derecesinde mevcuttur: Çözücü (çözücü kauçuğu), akrilik ve sıcak eriyik.

- a) **Çözücü (çözücü kauçuk):** Yüksek ve düşük sıcaklıklara karşı mükemmel direnç gösteren en evrensel tip.
- b) **Akrilik:** Ekolojik ve uzun süreli depolama için ideal.
- c) **Sıcakta eriyen:** Kolay yuvarlanma ve oda sıcaklığına dayanıklı.



We offer Clear, Brown and Custom Printed Polypropylene duct tapes.

Polypropylene (PP), also known as Polypropylene, is a thermoplastic polymer used in a wide variety of applications including packaging tapes. These tapes are available in 3 grades of adhesive: solvent (solvent rubber), acrylic and hot melt.



- a. **Solvent (solvent rubber):** Most universal type with excellent resistant against high and low temperatures.
- b. **Acrylic:** Ecological and ideal for long-term storage.
- c. **Hot melt:** Easy rolling and resistant to room temperature.

Taşıma Poşeti - Carry Bag



Rulo Poşet - Roll Bag



VCI Kağıt ve Poşet- VCI Paper and Bag

Barış Ambalaj, metal işleme endüstrisinde en yenilikçi korozyon koruma teknolojilerinden birini VCI (uçucu korozyon önleyici) kağıtları ve torbaları sunmaktadır. Ürünüze koruyucu yağlar ve sıvılar uygulamadan yüzey korozyonu önleyen aktif bir hava sahası içinde kimyasal bileşikleri yavaşça salırlarlar. Çantalar ve kutular içindeki metal parçaların korunması VCI kağıtları ve torbaları için tipik bir uygulamadır.



Barış Packaging is offering one of the most innovative corrosion protection technologies in the metalworking industry, VCI (Volatile corrosion inhibitor) Papers and Bags. They slowly release chemical compounds within a sealed airspace that actively prevents surface corrosion without applying any protective oils and liquids to your product. Protection of metal parts inside bags and boxes is a typical application for VCI papers and bags.



Sülfite Kağıt - Sulphite Paper

Suya ve yağlara karşı bariyer sağlayan Parafinli Kağıt ;

PARAFİNLİ KAĞIT, ürünlerinizi neme, suya ve yağlara karşı koruyan etkili ve ekonomik bir ambalajdır. Yağlanmış veya greslenmiş mekanik parçaların, fren disklerinin, dişli sistemlerinin rutubete karşı korunması için ideal.

Paraffin Paper providing barrier against water and oils ;

PARAFİNLİ PAPER is an effective and economical package that protects your products against moisture, water and oils. Ideal for the protection of lubricated or greased mechanical components , brake discs, gear systems against humidity .



Diğerleri - Others

Koruyucu Köşebent- Protective Angle

Streç - Stretch

Bağlama Ekipmanları - Binding Equipment









Factory

Fabrika - Firuzköy Mh. Bağlarıçi Cd.

No:73 Avcılar - İstanbul -Türkiye

Tel : +90 212 444 89 40

Faks: +90 212 612 01 62

e-mail: info@kutucum.com

www.kutucum.com



Europe Office

Keienbergweg 75 1101GE Amsterdam

Phone: +31 (0) 20 247 5552

e-mail: info@europackaging.com

www.europackaging.com

